

畑(A) 地割図

- | | | | | | | | | | |
|----|---|---|---|---|---|---|---|---|----|
| 1 | 2 | 3 | 4 | 5 | 6 | 7 | 8 | 9 | 10 |
| 2 | | | | | | | | | |
| 3 | | | | | | | | | |
| 4 | | | | | | | | | |
| 5 | | | | | | | | | |
| 6 | | | | | | | | | |
| 7 | | | | | | | | | |
| 8 | | | | | | | | | |
| 9 | | | | | | | | | |
| 10 | | | | | | | | | |

亀作ファーム
常陸太田市亀作町1252

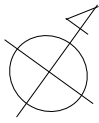

61号線側

道路

母屋

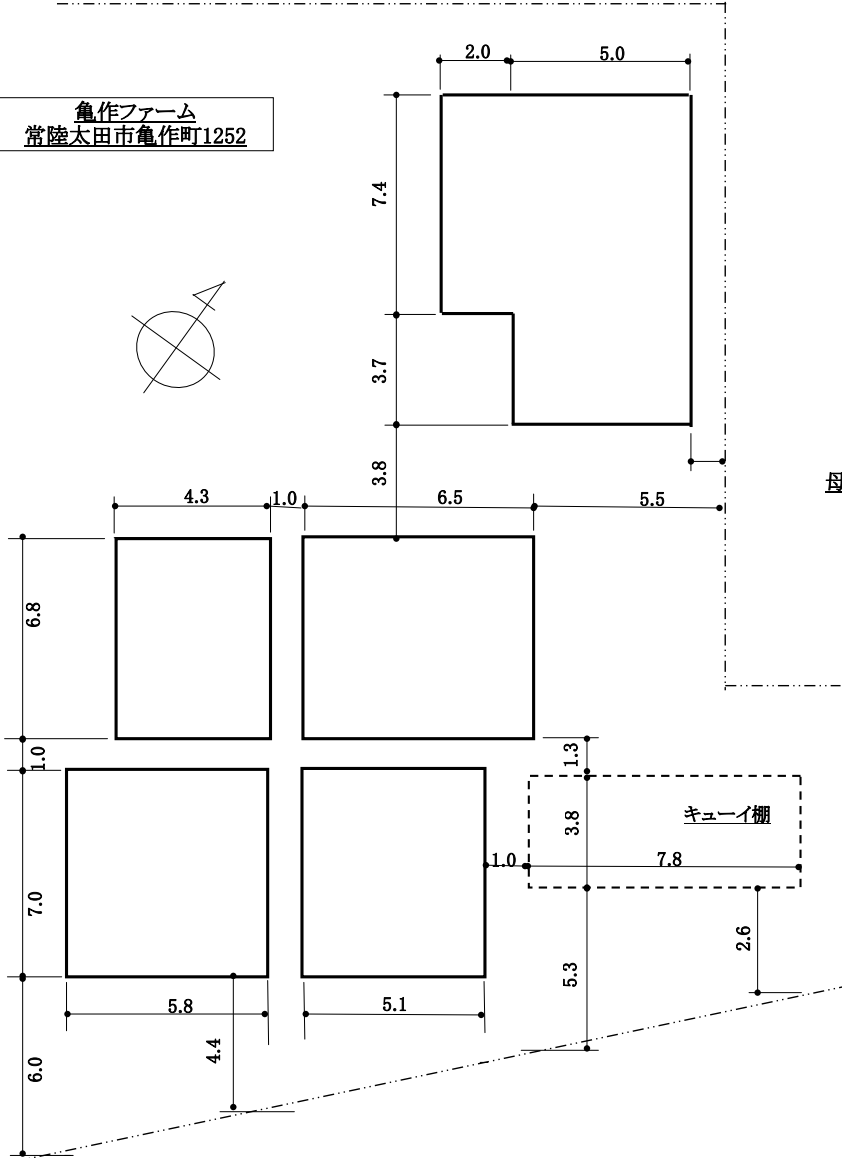

畑(D)側

畑(B) 地割図

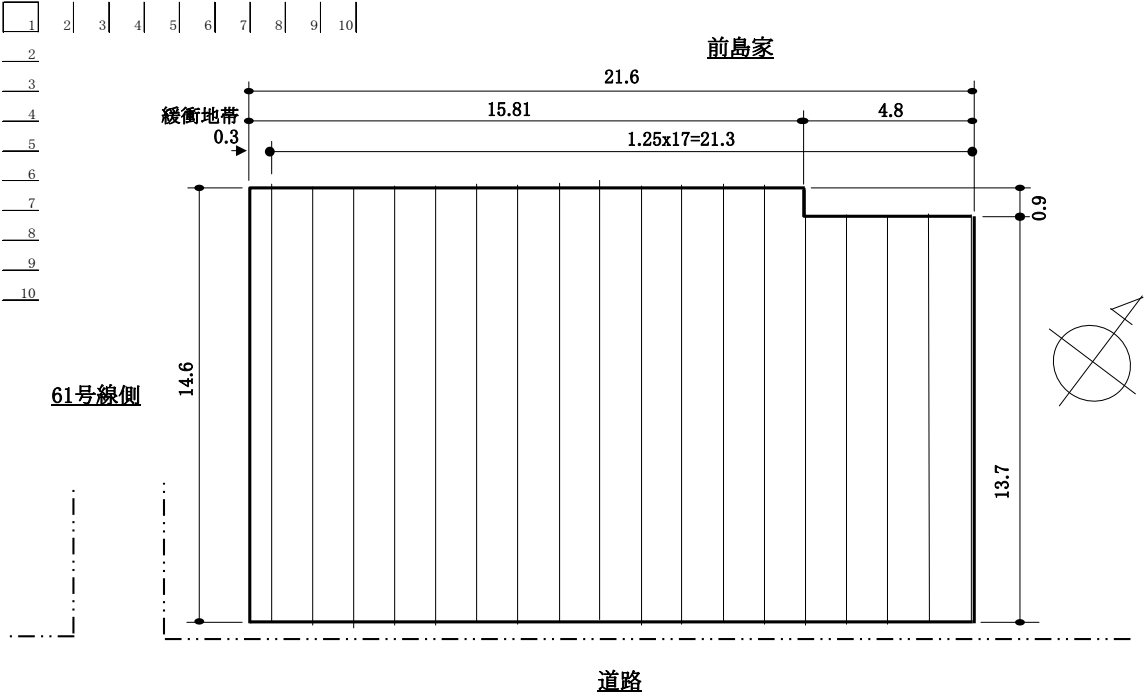

畑(C) 地割図

畑(A)側



2 単位:m

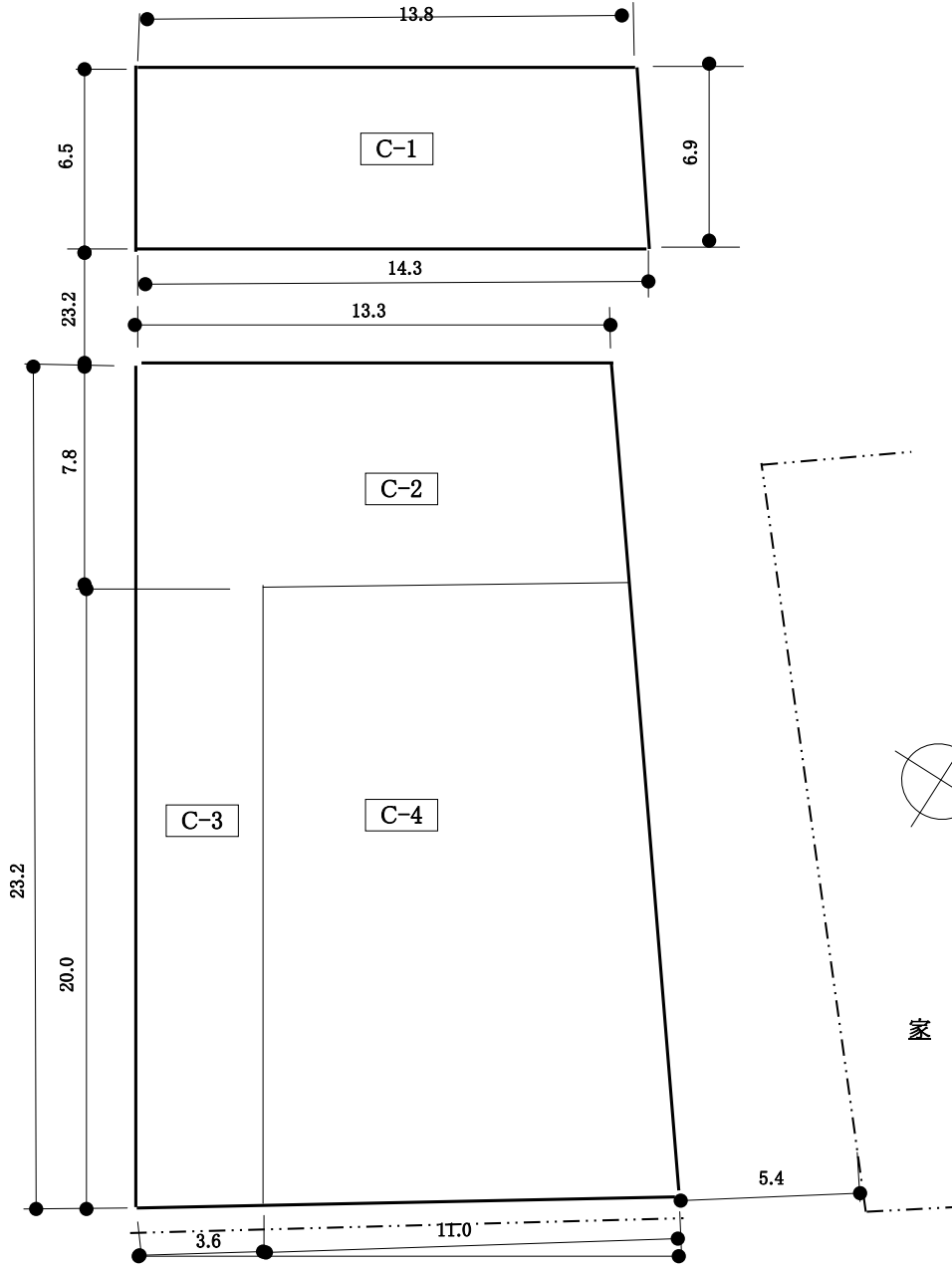
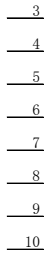

61号線側

畑(C) 地割図

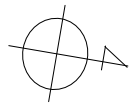
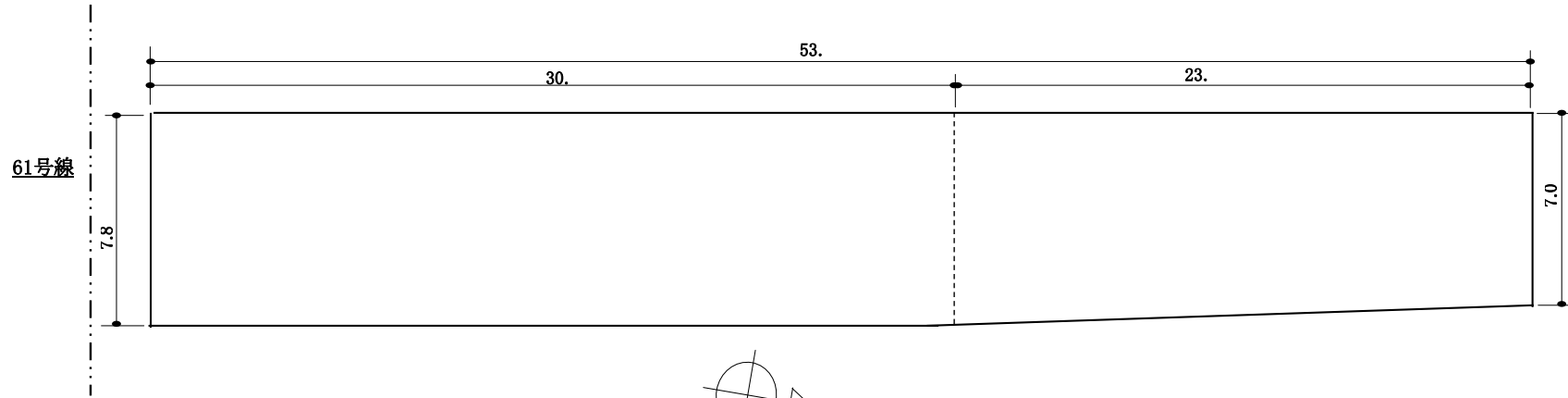

- 1
- 2
- 3
- 4
- 5
- 6
- 7
- 8
- 9
- 10

2 单位:m

- 3
- 4
- 5
- 6
- 7
- 8
- 9
- 10

面積計算

No.	畑No.	W (m)	H (m)	Square (m ²)	Total (m ²)	坪 (坪)	反 (反)	a (a)	Remark
1	A	2.0	7.4	14.8					
2		5.0	11.1	55.5					70.3
3									
4		4.3	14.8	63.6					
5		1.5	7.0	10.5					
6		6.5	6.8	44.2					
7		5.1	8.0	40.8					159.1
8		Total			229.4				
9									
10	B	15.8	14.6	230.7					
11		4.8	13.7	65.8					
12		Total			296.5				
13									
14	C	14.0	6.7	93.8					
15		13.3	7.8	103.7					
16		3.6	20.0	72.0					
17		13.8	20.0	138.0					
18	Total			407.5					
19									
24	Sum			933.4	282.4	0.94	9.33		